

# Analog Input Module

P3-04ADS



## Isolated Voltage/Current Analog Input

The P3-04ADS Isolated Voltage/Current Analog Input Module provides four isolated channels for receiving  $\pm 10$  VDC, 0 to 5 VDC, 0 to 10 VDC and 0 to 20mA signals.



Patent-pending LCD gives access to field signal values, as well as module and signal faults.

Terminal block sold separately; terminal block cover included with module.

We recommend using prewired ZIPLink cables and connection modules. See "Wiring Systems".

Terminal block cover included. If you wish to hand-wire your module, a removable terminal block is sold separately. Order part number P3-RTB.



## Removable Terminal Block Specifications

Description	Part No. P3-RTB; 20 screw terminals
Wire Range	22-14 AWG (0.324 to 2.08 sq. mm) Solid / stranded conductor 3/64 in. (1.2 mm) insulation maximum "USE COPPER CONDUCTORS , 60°C" or equivalent.
Screw Driver Width	1/4 inch (6.5 mm) maximum
Screw Size	M3 size
Screw Torque	Field terminals – 7 - 9 in./lb (.0882 - 1.02 Nm) Self-jacking screws – 2.7 - 3.6 in./lb (0.3 - 0.4 Nm). Do not overtighten screws when installing terminal block.

**WARNING:** Explosion hazard – Substitution of components may impair suitability for Class I, Division 2.

## Input Specifications

Input Channels	4 Channel-to-Channel Isolated
Module Signal Input Ranges	$\pm 10$ VDC, 0 - 5 VDC, 0 - 10 VDC, 0 - 20 mA
Signal Resolution	14-16 bit, depending on range jumpers
Range & Input Resolution See Note 1	$\pm 10$ V = 305 $\mu$ V, 16 bit 0-5V = 76.3 $\mu$ V, 14 bit 0-10V = 152 $\mu$ V, 15 bit 0-20mA = 0.305 $\mu$ A, 14 bit
Data Range	0 to 65535 counts unipolar -32768 to +32767 counts bipolar
Isolated Loop Pwr for Ext. Xmitters	20-30VDC, current limited to < 30 mA
Input Type	Differential
Common Mode Rejection Ratio	-75 dB min. @ DC, -500 kHz
Maximum Continuous Overload	$\pm 31$ mA., current input $\pm 100$ V, voltage input
Input Impedance	205k V $\pm 5\%$ voltage input 250 V $\pm 0.1\%$ 1/4W. current input
Filter Characteristics	Active low pass, -3dB @ 30Hz, -10dB @ 55Hz
Sample Duration Time	1.28 ms per channel (does not include ladder scan time)
All Channel Update Rate	5.2 ms
Open Circuit Detection Time	Zero reading within 1s
Conversion Method	Successive Approximation
Accuracy vs. Temperature	$\pm 25$ PPM / °C max
Maximum Inaccuracy	0.1% of range voltage, 0.2% of range current (including temperature drift)
Linearity Error (End to End)	$\pm 0.025\%$ of range maximum, Monotonic with no missing codes
Input Stability and Repeatability	$\pm 0.02\%$ of range maximum after 10 min.
Full Scale Calibration Error (not including Offset)	$\pm 0.05\%$ of range maximum
Offset Calibration Error	$\pm 0.05\%$ of range maximum
Max Crosstalk	-96 dB 1 LSB
Channel to Channel Isolation	900 VDC applied for 1 second
Recommended Fuse (external)	Edison S500-32-R, 0.032A fuse on current inputs only
External DC Power Required	NONE for the module

Note 1: 0-5V, 0-10V, and 0-20mA are 14, 15, and 14 bit respectively. The 14 and 15 bit input values are scaled to 0-65535.

## General Specifications

Operating Temperature	0° to 60°C (32° to 140°F),
Storage Temperature	-20° to 70°C (-4° to 158°F)
Humidity	5 to 95% (non-condensing)
Environmental Air	No corrosive gases permitted
Vibration	MIL STD 810C 514.2
Shock	MIL STD 810C 516.2
Field to Logic Side Isolation	1800 VAC applied for 1 second
Insulation Resistance	>10M $\Omega$ @ 500 VDC
Heat Dissipation	2.6 W
Enclosure Type	Open Equipment
Agency Approvals	UL508 file E157382, Canada & USA UL1604 file E200031, Canada & USA CE (EN61131-2*) This equipment is suitable for use in Class 1, Division 2, Groups A, B, C and D or non-hazardous locations only.
Module Keying to Backplane	Electronic
Module Location	Any I/O slot in any local, expansion, or remote base in a Productivity3000 System.
Field Wiring	Removable terminal block (not included). Use ZIPLink wiring system or optional terminal block. See "Wiring I/O Modules".
EU Directive	See the "EU Directive" topic in the Productivity3000 Help File. Information can also be obtained at: <a href="http://www.productivitypac.com">www.productivitypac.com</a>
Terminal Type (not included)	20-position removable terminal block
Weight	61g (2.14 oz)

\*Meets EMC and Safety requirements. See the Declaration of Conformity for details.

# Analog Input Module

## P3-04ADS (Cont'd)

### Wiring Diagrams

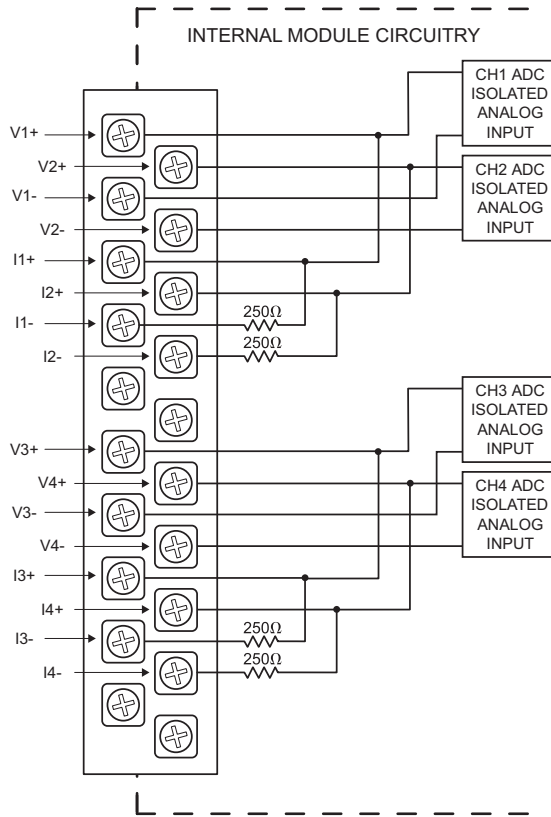

#### Unused Circuits

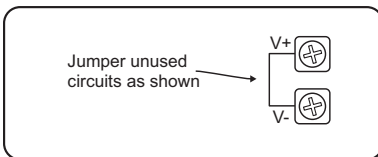

#### Voltage Input Circuits

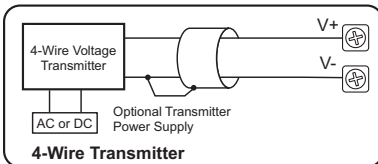

#### NOTES:

1. Shield connected to signal source common.
2. If current is chosen, I- **MUST** be jumpered to V-. For example, when using 4-20 mA source for Input 3, I3- must be connected to V3-.

#### Current Input Circuits

An Edison S500-32-R 0.032A fast-acting fuse is recommended for all 4-20mA current loops.

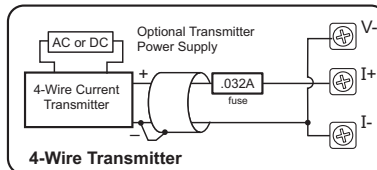
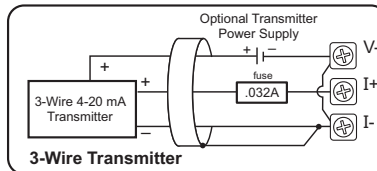
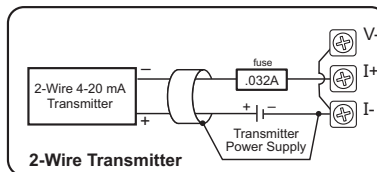



## Specify your ZIPLink system

Use the Compatibility Matrix table below.

<b>Step 1</b>	Locate the I/O module part number.
<b>Step 2</b>	Locate Connector Module Type. (Feedthrough Module, Fuse Module, etc...)
<b>Step 3</b>	Select the cable length by replacing the # symbol with: Blank = 0.5m, -1 = 1.0m, -2 = 2.0m <sup>1</sup>
<sup>1</sup> Note: Cable part number denotes compatibility between Connector Module and I/O Modules.	

Productivity3000 ZIPLink Wiring System Compatibility Matrix								
Step 2: Connector Module Type		Feedthrough Modules		Fuse Modules		Relay Module	Sensor Input Mod.	Pigtail Cable
Step 1: I/O Module	Number of Terminals	ZL-RTB20	ZL-RTB40	ZL-RFU20	ZL-RFU40	ZL-RRL16-24	ZL-LTB16-24	
Step 3: Cables								
<b>Inputs</b>								
<b>P3-08NAS</b>	20	ZL-P3-CBL20#						ZL-P3-CBL20-#P
<b>P3-08ND3S</b>	20	ZL-P3-CBL20#						ZL-P3-CBL20-#P
<b>P3-16NA</b>	20	ZL-P3-CBL20L#						ZL-P3-CBL20-#P
<b>P3-16ND3</b>	20	ZL-P3-CBL20L#						ZL-P3-CBL20-#P
<b>P3-32ND3</b>	40		ZL-CBL40#				ZL-P3-CBL40#	
<b>P3-64ND3*</b>	40		ZL-CBL40#				ZL-P3-CBL40#	
<b>Outputs</b>								
<b>P3-08TAS</b>	20	ZL-P3-CBL20#						ZL-P3-CBL20-#P
<b>P3-08TD1S</b>	20	ZL-P3-CBL20L#						ZL-P3-CBL20-#P
<b>P3-08TD2S</b>	20	ZL-P3-CBL20L#						ZL-P3-CBL20-#P
<b>P3-08TRS</b>	20	ZL-P3-CBL20#						ZL-P3-CBL20-#P
<b>P3-16TA</b>	20	ZL-P3-CBL20#		ZL-P3-CBL20L#				ZL-P3-CBL20-#P
<b>P3-16TD1</b>	20	ZL-P3-CBL20#		ZL-P3-CBL20#		ZL-P3-CBL20#		ZL-P3-CBL20-#P
<b>P3-16TD2</b>	20	ZL-P3-CBL20#		ZL-P3-CBL20#				ZL-P3-CBL20-#P
<b>P3-16TR</b>	20	ZL-P3-CBL20#		ZL-P3-CBL20#				ZL-P3-CBL20-#P
<b>P3-08TRS-1***</b>	20	ZL-P3-CBL20#						ZL-P3-CBL20-#P
<b>P3-32TD1</b>	40		ZL-CBL40#		ZL-CBL40#			
<b>P3-32TD2</b>	40		ZL-CBL40#		ZL-CBL40#			
<b>P3-64TD1*</b>	40		ZL-CBL40#		ZL-CBL40#			
<b>P3-64TD2*</b>	40		ZL-CBL40#		ZL-CBL40#			
<b>Analog In</b>								
<b>P3-04ADS</b>	20	ZL-P3-CBL20L#						ZL-P3-CBL20-#P
<b>P3-08AD</b>	20	ZL-P3-CBL20L#						ZL-P3-CBL20-#P
<b>P3-16AD-1</b>	20	ZL-P3-CBL20L#						ZL-P3-CBL20-#P
<b>P3-16AD-2</b>	20	ZL-P3-CBL20L#						ZL-P3-CBL20-#P
<b>P3-08RTD**</b>	Matched Only							
<b>P3-08THM**</b>	T/C Wire Only							
<b>Analog Out</b>								
<b>P3-04DA</b>	20	ZL-P3-CBL20L#						ZL-P3-CBL20-#P
<b>P3-08DA-1</b>	20	ZL-P3-CBL20L#						ZL-P3-CBL20-#P
<b>P3-08DA-2</b>	20	ZL-P3-CBL20L#						ZL-P3-CBL20-#P
<b>P3-06DAS-1</b>	20	ZL-P3-CBL20L#						ZL-P3-CBL20-#P
<b>P3-06DAS-2</b>	20	ZL-P3-CBL20L#						ZL-P3-CBL20-#P
<b>P3-16DA-1</b>	20	ZL-P3-CBL20L#						ZL-P3-CBL20-#P
<b>P3-16DA-2</b>	20	ZL-P3-CBL20L#						ZL-P3-CBL20-#P
<b>Analog Combo</b>								
<b>P3-8AD4DA-1</b>	20	ZL-P3-CBL20L#						ZL-P3-CBL20-#P
<b>P3-8AD4DA-2</b>	20	ZL-P3-CBL20L#						ZL-P3-CBL20-#P

\*The P3-64ND3, P3-64TD1, and P3-64TD2 modules have two 32-point connectors and require 2 ZIPLink cables and 2 ZIPLink connector modules.

\*\*These modules are not supported by the ZIPLink wiring system. Removable terminal block P3-RTB included.

\*\*\*The P3-08TRS-1 output module is derated, not to exceed 2A per point maximum when used with the ZIPLink wiring system.

# I/O Modules

A variety of discrete and analog I/O modules are available for use in local, expansion, and remote I/O bases. Specifications for each module are on the following pages.

A filler module is available for unused I/O module slots (part number P3-FILL).



## Discrete Input Modules

Productivity3000 Discrete Input Modules			
Part Number	Number of Inputs	Description	Price
P3-16SIM	16	Input Simulator Module	<--->
P3-08ND3S	8	Isolated Sinking/Sourcing DC Input	<--->
P3-16ND3	16	Sinking/Sourcing DC Input	<--->
P3-32ND3*	32	Sinking/Sourcing DC Input	<--->
P3-64ND3*	64	Sinking/Sourcing DC Input	<--->
P3-08NAS	8	Isolated AC Input	<--->
P3-16NA	16	AC Input	<--->

\*ZIPLink required.

## Analog I/O Modules

Productivity3000 Analog Input Modules			
Part Number	Number of Channels	Description	Price
P3-04ADS	4	Isolated Analog Input	<--->
P3-08AD	8	Analog Input	<--->
P3-16AD-1	16	Analog Input (Current)	<--->
P3-16AD-2	16	Analog Input (Voltage)	<--->
P3-08RTD	8	Analog RTD Input	<--->
P3-08THM	8	Analog Thermocouple Input	<--->

Productivity3000 Analog Output Modules			
Part Number	Number of Channels	Description	Price
P3-04DA	4	Analog Output	<--->
P3-08DA-1	8	Analog Output (Current)	<--->
P3-08DA-2	8	Analog Output (Voltage)	<--->
P3-06DAS-1	6	Isolated Analog Output (Current)	<--->
P3-06DAS-2	6	Isolated Analog Output (Voltage)	<--->
P3-16DA-1	16	Analog Output (Current)	<--->
P3-16DA-2	16	Analog Output (Voltage)	<--->

Productivity3000 Analog Input/Output Modules			
Part Number	Number of Channels	Description	Price
P3-8AD4DA-1	8/4	Analog Input/Output (Current)	<--->
P3-8AD4DA-2	8/4	Analog Input/Output (Voltage)	<--->

## Discrete Output Modules

Productivity3000 Discrete Output Modules			
Part Number	Number of Outputs	Description	Price
P3-08TD1S	8	Isolated Sinking Output	<--->
P3-08TD2S	8	Isolated Sourcing Output	<--->
P3-16TD1	16	Sinking Output	<--->
P3-16TD2	16	Sourcing Output	<--->
P3-32TD1*	32	Sinking Output	<--->
P3-32TD2*	32	Sourcing Output	<--->
P3-64TD1*	64	Sinking Output	<--->
P3-64TD2*	64	Sourcing Output	<--->
P3-08TAS	8	Isolated AC Output	<--->
P3-16TA	16	AC Output	<--->
P3-08TRS	8	Isolated Relay Output	<--->
P3-16TR	16	Relay Output	<--->
P3-08TRS-1	8	Isolated Relay Output	<--->

\*ZIPLink required.

## Module Installation Procedure



**WARNING:** Do not apply field power until the following steps are completed. See hot-swapping procedure for exceptions.

**Step One:** Align circuit card with slot and press firmly to seat module into connector.

**Step Two:** Pull top and bottom locking tabs toward module face. Click indicates lock is

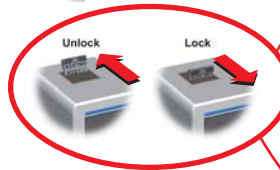

**Step Three:** Attach field wiring using optional terminal block or ZIPLink wiring system and install cover.



To install or remove terminal block cover, press middle to flex cover.



**WARNING:** Explosion hazard – Do not connect or disconnect connectors or operate switches while circuit is live unless the area is known to be non-hazardous. Do not hot-swap modules unless the area is known to be non-hazardous.